

**Race Management System
Instruction Manual**

Westhold Corporation General Warranty

Modules and other equipment ("Goods") purchased from Westhold Corporation are warranted against defects in materials and workmanship under normal use for a period of three years from the date of purchase. In the event of product failure due to defects in materials or workmanship, the customer may return the defective product to Westhold Corporation for repair or replacement. The customer is responsible for all shipping charges associated with shipping the Goods back to Westhold Corporation. Westhold Corporation pays shipping charges associated with the return of Goods back to the customer. As Westhold Corporation will not be responsible for damages incurred during any incoming shipment, it is recommended that the customer insure their shipment through their carrier.

Westhold Corporation shall, at its sole option, repair or replace the Goods. Repair or replacement of Goods is Westhold Corporation's sole obligation and the customer's exclusive remedy for all claims of defects. If that remedy is adjudicated insufficient, Westhold Corporation shall refund the customer's paid price for the Goods and have no other liability to the customer.

Westhold Corporation's software, if included with Goods, is sold as is, and this warranty is inapplicable to such software.

This warranty does not cover and Westhold Corporation will not be liable for, any damage or failure caused by misuse, abuse, acts of God, accidents, electrical irregularity, or other causes beyond Westhold Corporation's control, or claim by other than the original purchaser. This warranty is void if Westhold Corporation, in its sole discretion, determines that there has been any:

1. Tampering, signs of tampering, alteration, modification, or other indications or abuse.
2. Application of power outside of the voltage level and polarity specified in the data sheet or user's manual.
3. Repair or attempt to repair by anyone other than a Westhold Corporation authorized technician.

This is our entire warranty and is given in lieu of all other possible warranties, either express or implied, including warranties of merchantability and of fitness for a particular purpose. By accepting delivery of the Goods, Purchaser/User waives all other possible warranties, except those specifically given.

IN NO EVENT SHALL WESTHOLD CORPORATION BE LIABLE FOR ANY CONSEQUENTIAL, INCIDENTAL, INDIRECT, SPECIAL OR PUNITIVE DAMAGES ARISING OUT OF OR RELATING IN ANY WAY TO ANY DEFECT IN OR FAILURE OF OR INABILITY TO USE THE GOODS, INCLUDING BUT NOT LIMITED TO, CLAIMS BASED UPON LOSS OF USE, LOSS OF TIME, INCONVENIENCE, COMMERCIAL LOSS, LOST PROFITS, REVENUE OR SAVINGS, LOST GOODWILL, ENVIRONMENTAL DAMAGE, INCREASED EXPENSES OF OPERATION, COST OF REPLACEMENT GOODS, OR CLAIMS OF THE CUSTOMER OR CUSTOMER'S CUSTOMERS, WHETHER OR NOT BASED ON CONTRACT, TORT (INCLUDING NEGLIGENCE AND STRICT LIABILITY) OR OTHERWISE. WESTHOLD CORPORATION'S MAXIMUM LIABILITY UNDER THIS WARRANTY SHALL NOT EXCEED THE PAID PRICE FOR THE GOODS UPON WHICH SUCH LIABILITY IS BASED AND ALL SUCH LIABILITY SHALL TERMINATE NO LATER THAN ONE YEAR FROM THE DATE OF DELIVERY OF THE GOODS.

Note: Westhold Corporation's Goods are sold for resale or for commercial purposes, and are thus not covered under the Magnuson-Moss Warranty Act.

1. Introduction

The Westhold RMS is a sophisticated multi-component system used for the timing, scoring and management of motor sports racing events. The RMS consists of electronic hardware and PC based MS-Windows® software. A basic hardware setup includes a computer, IDEC decoder, Loop Antenna, and transmitters (also know as transponders). See fig. 1.1

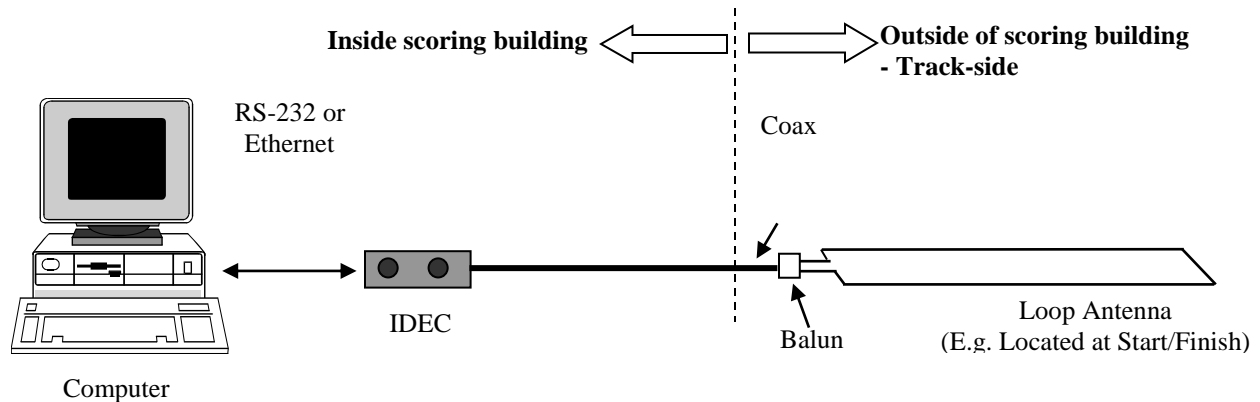

Fig 1.1 - Basic RMS Configuration

Each transmitter transmits a unique identification number. When a transmitter crosses a Loop Antenna, the IDEC reads this number and determines the crossing time of the transmitter. The IDEC compiles all of the information and sends it to the computer over a serial or Ethernet link for final analysis and storage. Data can then be sent from the computer to other devices such as scoreboards, printers, wireless hand-held lap time viewers and other third party devices.

IDEC is a receiver system that processes the raw signals picked up by the Loop Antenna. Its job is to convert the raw signals into digital information that can then be transmitted via a RS-232 serial link or a network link to the PC. A dual port IDEC can cover two timing points such as start/finish and pits. Multiple IDECs may be attached to a network to cover multiple timing points for information such as split times (see fig. 1.2), pit row activity or freeze-the-field information. This requires a GPS to synchronize all the IDECs to a common time.

Each IDEC stores what are known as hit records. Hit records describe the crossing of transmitters over the Loop Antennas. Each record consists of a transmitter identification number, the crossing time as well as a few other pieces of information such as transmitter battery status. The IDEC is capable of storing hit records in its internal memory for future reference and redundancy and is capable of determining a crossing time with spatial accuracy typically between 2-3 inches or better. Under normal operation, the PC would upload this data and process it as the transmitters cross the Loop Antennas. However, in the event of a computer failure the IDEC could still save hit records for later retrieval.

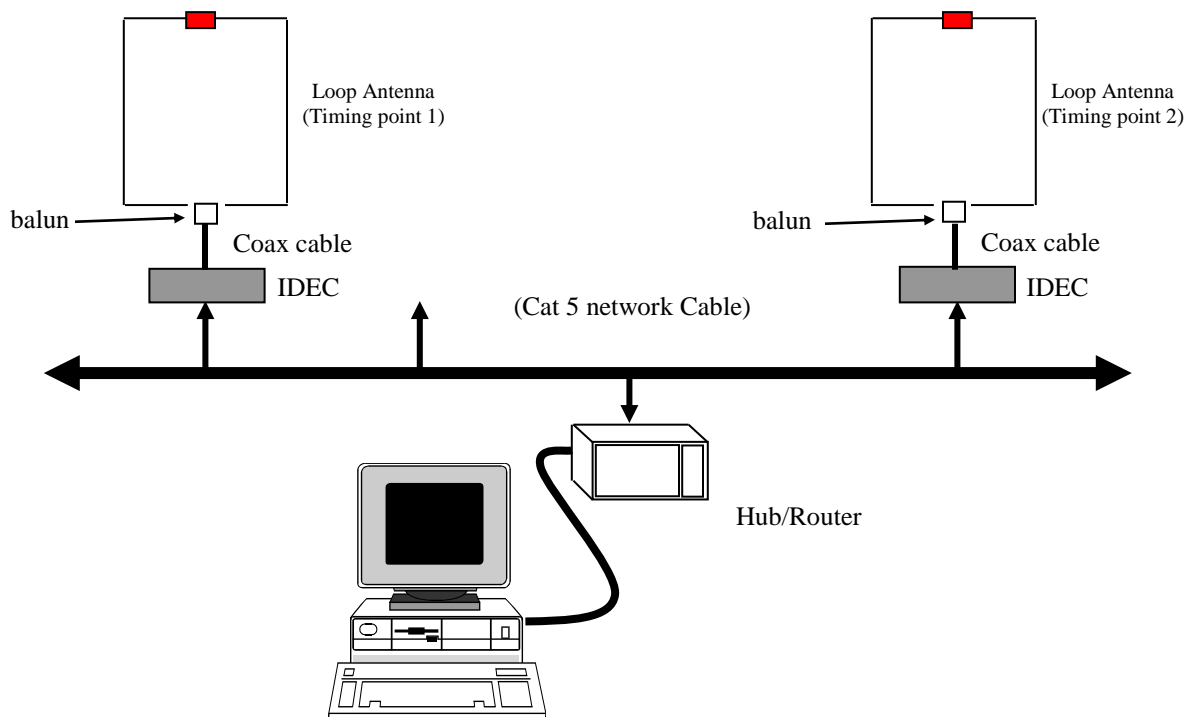

Fig 1.2 Multiple Timing Point Configuration

A Loop Antenna is simply insulated electrical wire with a terminating resistor on the side of the loop furthest from the connection to the Decoder. They are buried beneath the surface of the track and are 24 inches (approx. 60 cm) wide and can be of varying length to cover the width of the track. See fig 1.4. A track width greater than 100 ft. (approx. 30m) can be covered with a single Loop Antenna, but it depends on the track type (dirt versus paved), burial depth of the loop, and the track environment (iron content in the soil or RF interference). It is not desirable to make the Loop Antenna any longer than necessary since it will reduce the performance of the system.

The ends of the Loop Antenna connect to the balun. The balun is a device that connects the Loop Antenna to a RG58 (50 ohm) coax cable. The balun device matches the impedance between the Loop Antenna section and the coax. It is necessary to have a balun device for optimal performance. Without it the impedance mismatches can result in reduced detection height and possibly intermittent and unpredictable behavior.

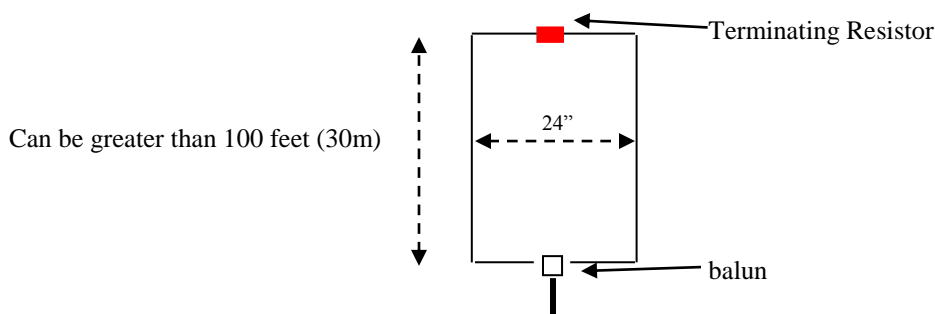

Fig. 1.3 - Loop Antenna Dimensions

2. Installation and Usage

2.0 General Notes

The first step in an installation is to carefully plan where each piece of the system will reside. The plan must take into account the limitations of the system. Some of these limitations are fixed. Others are variable and dependent upon the track environment.

2.1 Antenna Installation

There are two methods for setting up the antenna; the single loop and multi-loop methods. See the figures 2.1.1 and 2.1.2 below for the single and two loop setups. All loops should be about 24 inches wide with the resistor centered at the end of the loops. For multi-loop antennas each loop should overlap the adjacent loop by at least the burial depth of the loop. For example if the loop is buried at 18 inches then the overlap should be at least 18 inches. For depths less than 1 foot the minimum overlap should be 1 foot.

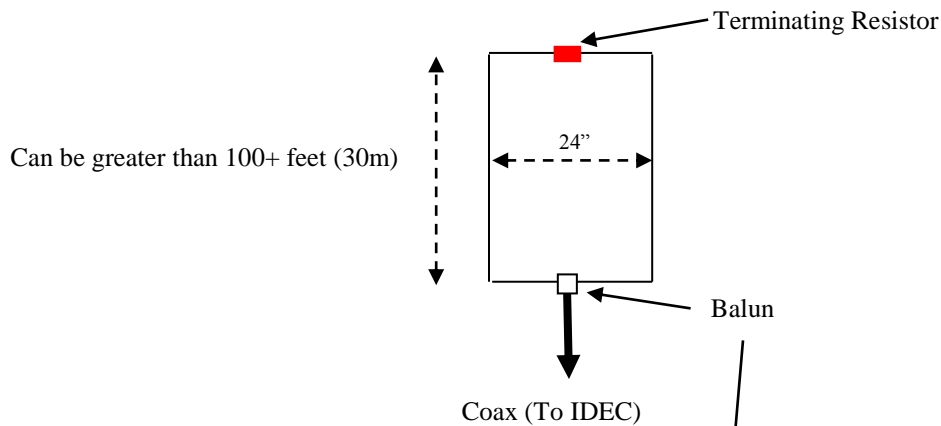

Fig 2.1.1 Single loop



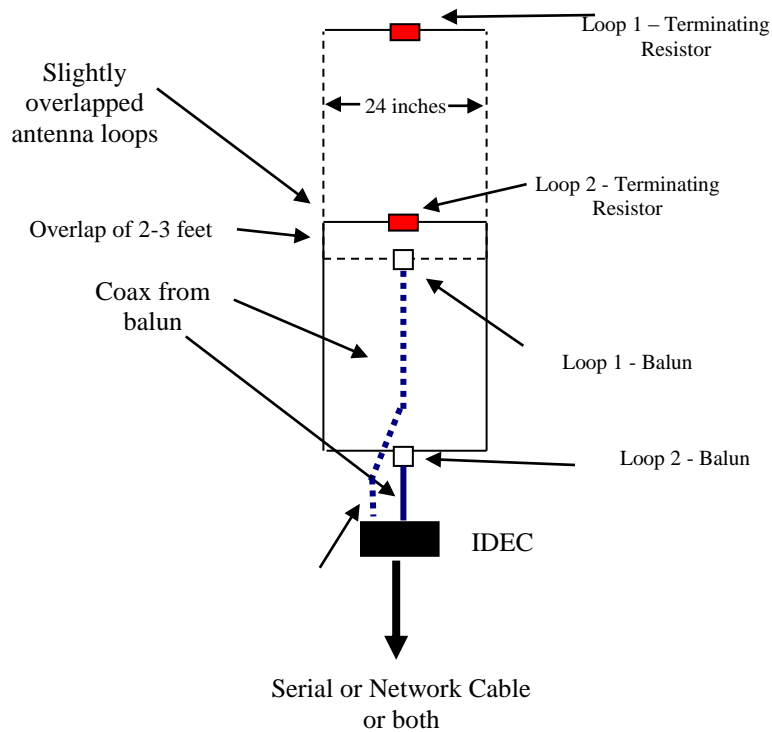

Fig 2.1.2 – Multi-loop

Antenna loops are simply insulated copper electrical wire with a resistor soldered to the end of the loop. If you prefer to make loops yourself or have a special need, the wire can be purchased at most hardware stores while the resistor (470 ohm optimal) is available at many electronic stores.

Note: The instructions below are only to make the detection loop. For activation loops do not follow the instructions below. They will result in a non-operational activation loop.

The wire may be stranded or solid core. A typical gauge of wire used is AWG 20. Smaller or larger gauges may be used. There are certain trade-offs to using smaller or larger gauges. For example, a smaller gauge is generally less durable, but is often more flexible and easier to manipulate.

Recommended:

Wire Type: Stranded core.

Resistor: Use approximately 470 ohms. Some deviation from this number is ok. Using a 390 ohm or 490 ohm resistor will not significantly affect the performance.

Heat shrink tubing: We suggest using heat shrink to encase the resistor and any exposed wire. This will keep moisture from seeping into the wire and eating away the copper.

To install the antenna loop, cut a groove approximately ¼ inch (6-8 mm) wide and ½ inch (12-13 mm) deep in the track with the dimensions show below. See fig. 2.1.1. Depending on the wire gauge the groove dimensions should be adjusted accordingly. For dirt tracks, place the antenna loops in plastic PVC sprinkler pipes. Make sure the pipes are sealed such that water will not enter the pipes.

There is no fixed depth to bury the antenna for dirt tracks. This is variable depending on the track. Environmental factors such as metal content in the soil can reduce detection distance and therefore the antenna cannot be buried as deeply as soil without metal content. The general rule of thumb is to bury the antenna only as deep as necessary to keep the antenna from being damaged, yet maintaining maximum detection distance between the antenna and the transmitter on the vehicle. Generally keeping the antenna burial depth to less than 18 inches is recommended. This typically is deep enough so cars and graders do not harm the antenna, but still maintaining good detection distance.

Connect the ends of the Loop Antenna to the balun device. There are two screw terminals on the device for the antenna wire. A BNC connector is on the opposite end of the balun. Connect the coax cable to the BNC connector. The other end of the coax cable will then connect to the BNC connector on the back of the Decoder.

2.2 IDEC Decoder System

A single or multi-port IDEC setup can be used. For multiple timing points the IDEC has the capability to synchronize to a GPS time with a GPS receiver. The IDEC will either have 1 or 2 inputs for antenna. For a 2 port system the loops may be used in various configurations: start/finish and pit, overlapping loops, split time, or separate start and finish.

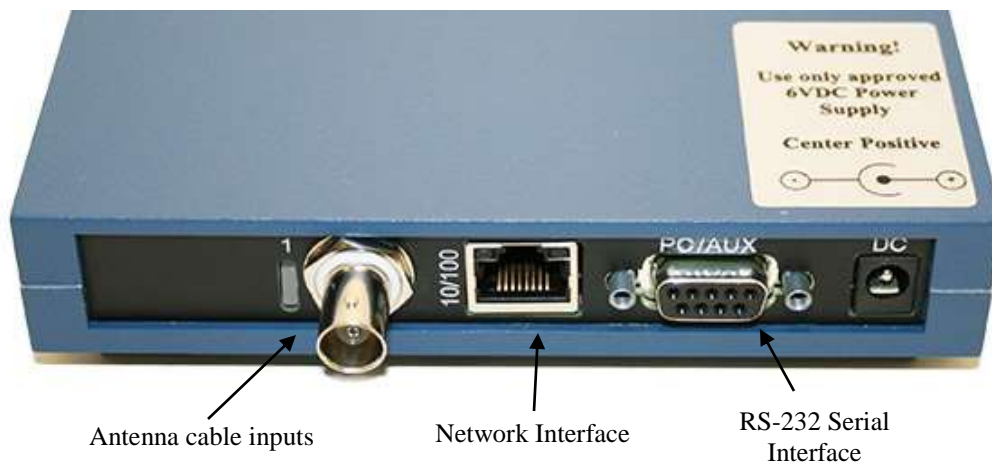

Fig. 2.2.1 IDEC Rear Panel (1 Port System)

The IDEC has 3 front panel LED indicators to indicate power, communications activity with a PC and transmitter crossings. The PWR (power) indicator will light green if the DC power supply is high enough to properly operate the system. The IDEC uses a 6 volt DC power supply. If the voltage is too low the LED will light red.

The communication (COM) indicator lights a solid green when it is first power on and will stay a solid green until there is communications with a PC either through the serial or Ethernet interface. When there is communications the COM indicator will blink.

The detection (DET) light will flash green whenever a valid transmitter has crossed the loop. It will stay on solid green if a transmitter is sitting over the loop and does not move out of detection range to indicate a real crossing.



Fig. 2.2.2 IDEC Front Panel

The IDEC comes with a 6 volt DC power supply. First, plug in the communication cable that will be used whether it is the RS-232 serial cable or a network cable. If the IDEC is connected to a hub, switch, or router, use a standard CAT-5 network cable. If the IDEC is connected directly to the computer via the network interface you must use a CAT-5 crossover network cable. If a network cable is used it should be plugged into a hub or router device. The IDEC comes configured with a static IP address, 192.168.1.49. However, it can be setup to obtain an IP address automatically via the web configuration interface. Make sure the PC is on the same domain as the IDEC (i.e. 192.168.1.X) or you will be unable to connect via network to the IDEC.

To access the web interface, use the following username and password (cap sensitive).

Username: admin

Password: PASS

Note: Both communication interfaces may be used simultaneously. This allows for a second PC to be connected as a backup system.

After plugging in the communication cable, plug in the coax cable(s) from the antenna loops. Once this is done connect the 6 VDC power supply. You will see the PWR indicator and COM indicator light up. Follow the software instructions to connect with the IDEC.

2.3 Transmitters/Transponders

Transmitters are often called transponders. Technically, most transmitters are not transponders. Transponder is short for transmitter-responder. In the case of timing systems, a transponder is a transmitter that transmits when it receives an activation signal. There are 3 types of transmitters: rechargeable, hard-wire, and activated. All transmitters have a unique identification number that is printed on the outside of the transmitter case. When the transmitter crosses an antenna loop the ID is received by the IDEC and sent to the scoring software.

Rechargeable Transmitter

The rechargeable transmitter operates using an internal non-removable battery. There are two LEDs, one green and one red on the transmitters. When the transmitters are fully charged and operational they will operate for 7 days. The green LED will blink rapidly every 3 seconds. The number of rapid blinks indicates the number of days of charge left before the transmitter will shut off. When the transmitter is on the last day, it will begin to blink the red LED once ever 3 seconds. When this happens the timing software will receive a low battery signal from the transmitter.



Fig 2.3.1 Rechargeable Transmitter

Rechargeable transmitters are mounted on vehicles using one of two types of holders. One type of holder is a plastic holder with two wings for bolting to a vehicle. The other type is a nylon fabric pouch variety with wings for bolting to a vehicle.

Note: Be sure to securely fasten the transmitter to the vehicle before use. Unsecured transmitters can be hazardous if they fall on the track.

Hard-wire Transmitter

The hard-wire transmitter uses a vehicles 12 volt DC power source. It has an operational voltage approximately between 8.5-25 VDC (older models have a max of 16VDC). If the voltage is high enough for the unit to operate properly it will flash the green LED light. If the red LED indicator lights up or no LED lights turn on at all the voltage level or current supplied is not enough.



Fig. 2.3.2 Hard-wire Transmitter

When connecting the leads from the hard-wire to the vehicle power source a fuse should be used in series to protect the transmitter. The hard-wire draws less than 30 milliamps. Even though this current draw is low, the transmitter should be hooked in such a way that it is turned off when the vehicle is not running to prevent the battery from being drained.

The best possible orientation of the rechargeable and hard-wire transmitters is shown below with the label side of the transmitter facing the ground Fig 2.3.3. **It is important that the transmitter has no metal or carbon fiber between it and the track surface.** Metal and carbon fiber will block the signal emanating from the transmitter and the IDEC will not be able to pick up crossing transmitters.

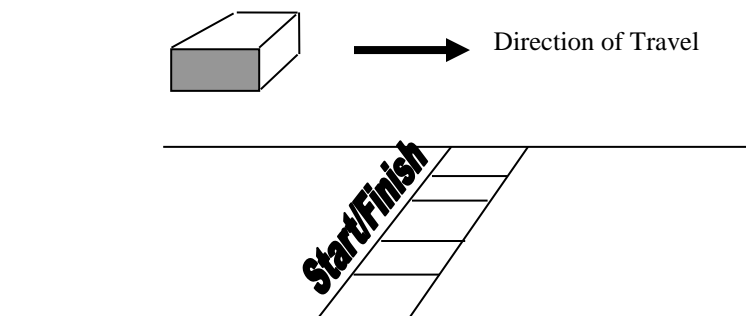

Fig 2.3.3

Activated Transmitter/Transponder

The activated transmitter only turns on when it detects an activation signal from the Westhold activator and activation loop. When the unit is on, a green LED indicator will flash every 3 seconds. It will blink the approximate number of hours of life remaining. Each blink signifies 100 hours. If the red LED light flashes it means the battery is on its last 100 hours.



Fig 2.3.4 Activated Transmitter

The activated transmitter is small enough to be strapped to a motocross boot or a motorcycle fork. Unlike the other two units, the label for this transponder type should be vertical. See Fig 2.3.5 for correcting mounting position.

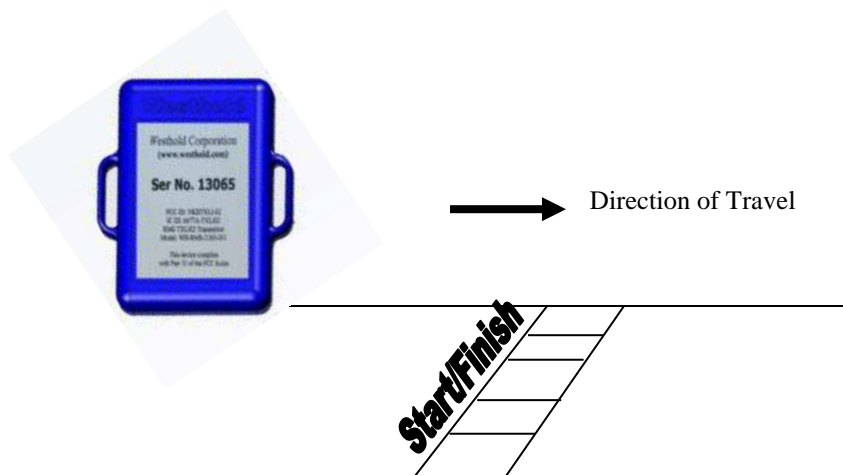

Fig 2.3.5

Refer to the instructions for each individual transmitter type for more detailed information.

3. Specifications

The RMS is capable of detecting transmitter crossings over the middle of a Loop Antenna with a spatial accuracy of typically 2-3 inches or less and a resolution of better than one ten-thousandths of a second. For a transmitter traveling at 200 miles per hour, that translates into sub-millisecond accuracy.

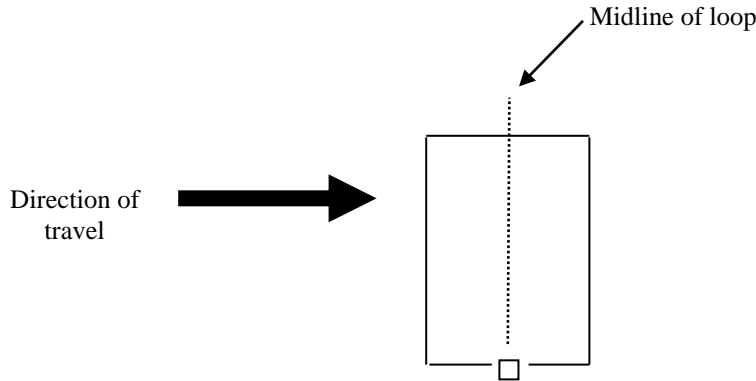

Fig 3.1.1 Direction of travel

System Specifications:

Specification	
# Transmitter Ids	> 1,000,000
Max Speed	Transmitter dependent Up to 300+ mph
Track Width	100+ feet (Depends on track type and environment)
Spatial Accuracy	2-3 inches typical
Timing Resolution	better than 0.0001 sec
Max Transmitter Height	Vehicle and track and transmitter dependent (24-48 inches typical)

Component Specifications:

IDEC	
Dimensions	6" x 5" x 2" (≈15 x 13 x 2.5 cm)
Interface to PC	RS232 or Ethernet
Power Supply	6VDC, 1A, Center Positive
Multiple IDECs	Yes
Internal Clock Stability	Up to 0.5 ppm
External Clock Source	GPS Capable
Coax from Loop Antenna to IDEC	Up to 1000 feet (300m) depending on conditions
Memory	FLASH - 64,000 crossings

Transmitter - Rechargeable	TXLI Model
Dimensions	Approx. 3" x 2" x 1" (≈7.6 x 5.1 x 2.5cm)
Weight	Approx. 4.9oz (125grams)
Temp Range	32-122°F (0-50°C)
Battery Life	7 Days on full charge
Operational Indicator	LED
Low Battery Indicator	LED
Humidity	90% Relative

Transmitter - Hardwire	TXDP Model
Dimensions	Approx. 3" x 2" x 1" (≈7.6 x 5.1 x 2.5cm)
Weight	Approx. 4.3oz (122grams)
Temp Range	32-122°F (0-50°C)
Voltage	+14 V > voltage > +9 V
Current	< 30 milliamps
Operational Indicator	LEDs
Humidity	90% Relative

Transmitter - Activated	TXACT Model
Dimensions	Approx. 2.5" x 2" x 0.7" (≈6.2 x 5.4 x 2cm)
Weight	Approx. 2.6oz (75grams)
Temp Range	32-122°F (0-50°C)
Battery Life	Depends on usage Normal use is about 2-3 years
Operational Indicator	LEDs
Humidity	90% Relative

4. FCC Notices

RMS IDEC FCC Declarations:

**FEDERAL COMMUNICATIONS COMMISSION RADIO AND TELEVISION INTERFERENCE
STATEMENT FOR A CLASS 'B' DEVICE**

This equipment has been tested and found to comply with the limits for a Class B digital device, pursuant to Part 15 of the FCC Rules. These limits are designed to provide reasonable protection against harmful interference in a residential installation. This equipment generates, uses and can radiate radio frequency energy and, if not installed and used in accordance with the instructions, may cause harmful interference to radio communications. However, there is no guarantee that interference will not occur in a particular installation. If this equipment does cause interference to radio or television reception, which can be determined by turning the equipment off and then on, the user is encouraged to try to correct the interference by one of more of the following measures:

- Reorient or relocate the receiving antenna.
- Increase the separation between the equipment and receiver
- Connect the equipment into a different outlet so that the equipment and receiver are on different branch circuits.
- Consult the dealer or an experienced radio/TV technician for help.

This device complies with Part 15, of the FCC Rules. Operation is subject to the following two conditions: (1) this device may not cause harmful interference, and (2) this device must accept any interference received including interference that may cause undesired operation.

Changes or modifications not expressly approved by **Westhold Corporation** could void the user's authority to operate the equipment.

TXLI RMS Rechargeable Transmitter FCC Declaration:

**FEDERAL COMMUNICATIONS COMMISSION RADIO AND TELEVISION
INTERFERENCE STATEMENT**

Changes or modifications not expressly approved by *Westhold Corporation* could void the user's authority to operate the equipment.

This device complies with Part 15 of the FCC Rules. Operation is subject to the following two conditions: (1) this device may not cause harmful interference, and (2) this device must accept any interference received including interference that may cause undesired operation.

**FCC ID: NKBTXLI-01, NKBTXLI-02,
IC: 677A-TXLI02**

TXDP RMS Hardwire Transmitter FCC Declaration:

**FEDERAL COMMUNICATIONS COMMISSION RADIO AND TELEVISION
INTERFERENCE STATEMENT**

Changes or modifications not expressly approved by *Westhold Corporation* could void the user's authority to operate the equipment.

This device complies with Part 15 of the FCC Rules. Operation is subject to the following two conditions: (1) this device may not cause harmful interference, and (2) this device must accept any interference received including interference that may cause undesired operation.

FCC ID: NKBTXDP-01

IC ID: 677A-TXDP01